

INSTRUCTION MANUAL 86071

ALARM CHRONOGRAPH MODULE

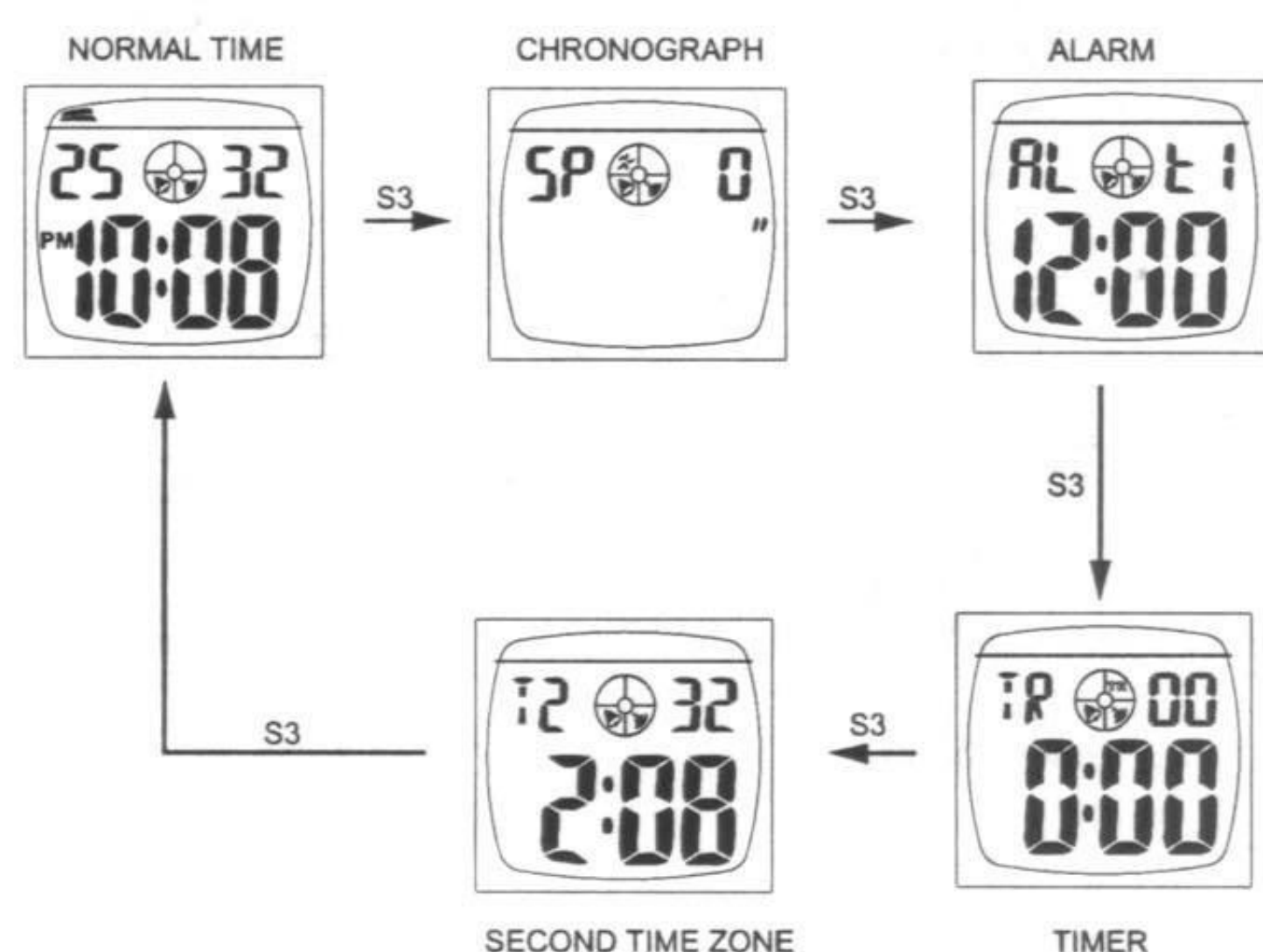

HOW TO CHANGE THE DISPLAY MODE



HOW TO SET NORMAL TIME/CALENDAR

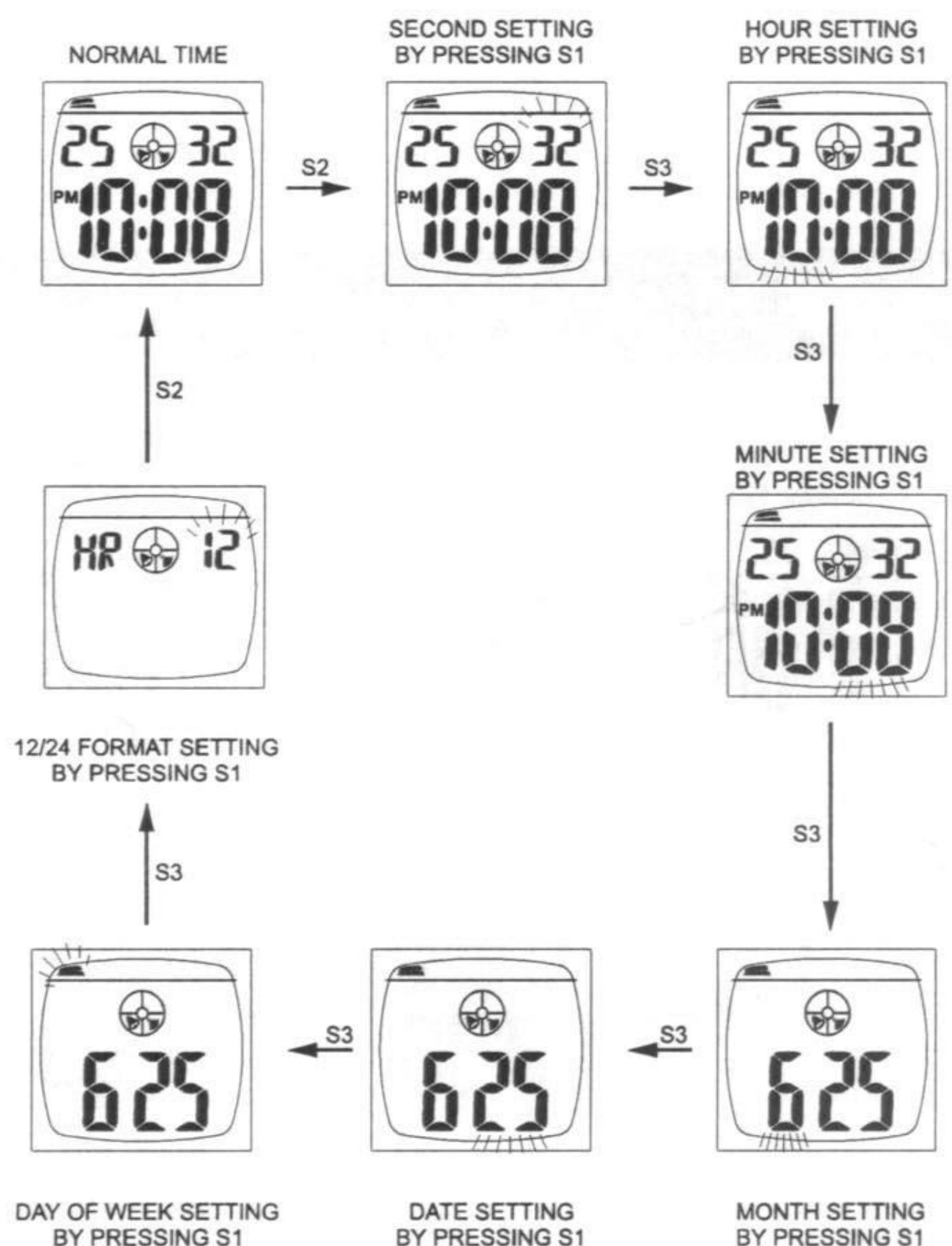

CARE OF YOUR WATCH

1. This watch contains electronic components. Never attempt to open the case or remove the back cover.
2. Do not operate push buttons below the surface of the water while swimming or diving.
3. Should water or condensation appear in the watch, have the watch checked immediately. Corrosion of electronic parts can occur inside the case.
4. Avoid severe impact. The watch is designed to withstand impact under normal use. It is inadvisable to subject it to severe impact or rough usage.
5. Avoid exposing the watch to extreme temperature.
6. Clean the watch with soft cloth and clean water only. Avoid using chemicals, The waterproof gasket will corrode.
7. Keep your watch away from the conditions of strong electric field and static electricity.

REGULAR DISPLAY AND BUTTON OPERATION

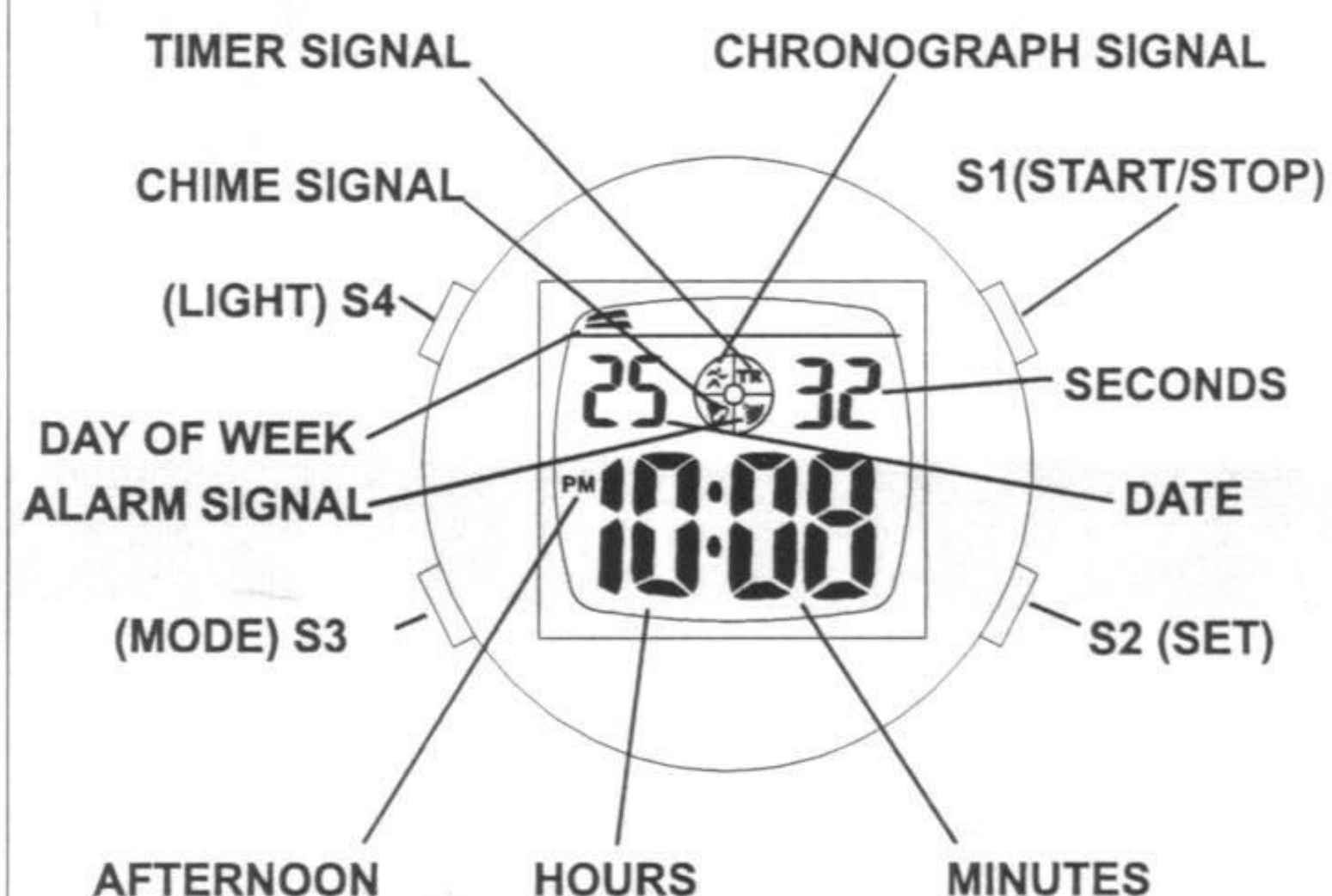

(Battery: CR2032)

- ▶ HOLD S1 BUTTON, MONTH & DATE WILL DISPLAY.
- ▶ EL IS TURN-ON FOR THREE SECONDS WHEN S4 BUTTON IS DEPRESSED.
- ▶ WHEN S1, S2 AND S3 BUTTONS ARE DEPRESSED SIMULTANEOUSLY, LCD ALL-ON, EL-ON AND BUZZER-ON WILL OCCUR.

HOW TO USE THE CHRONOGRAPH

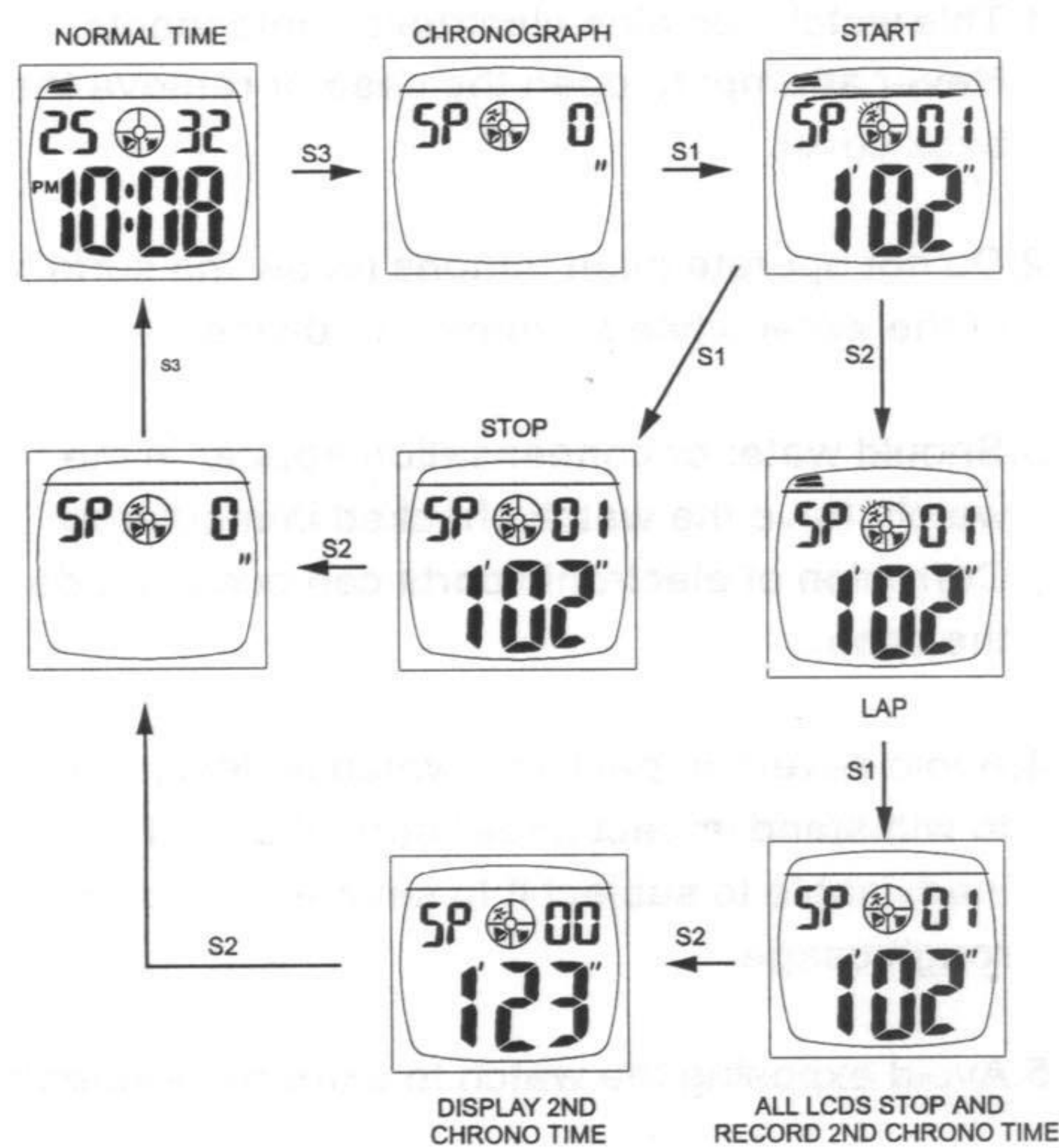

HOW TO SET ALARM TIME

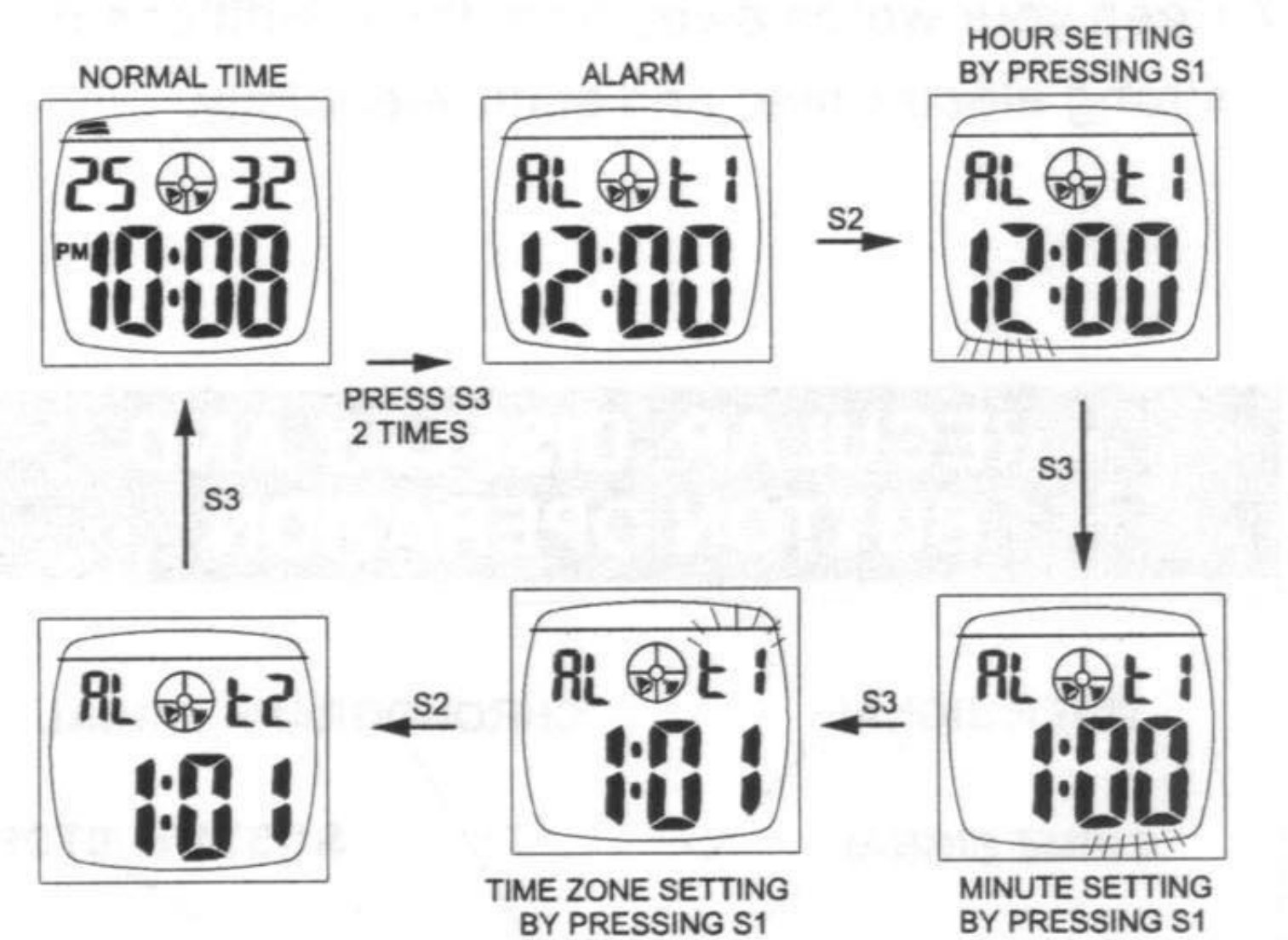

ALARM & CHIME ON/OFF

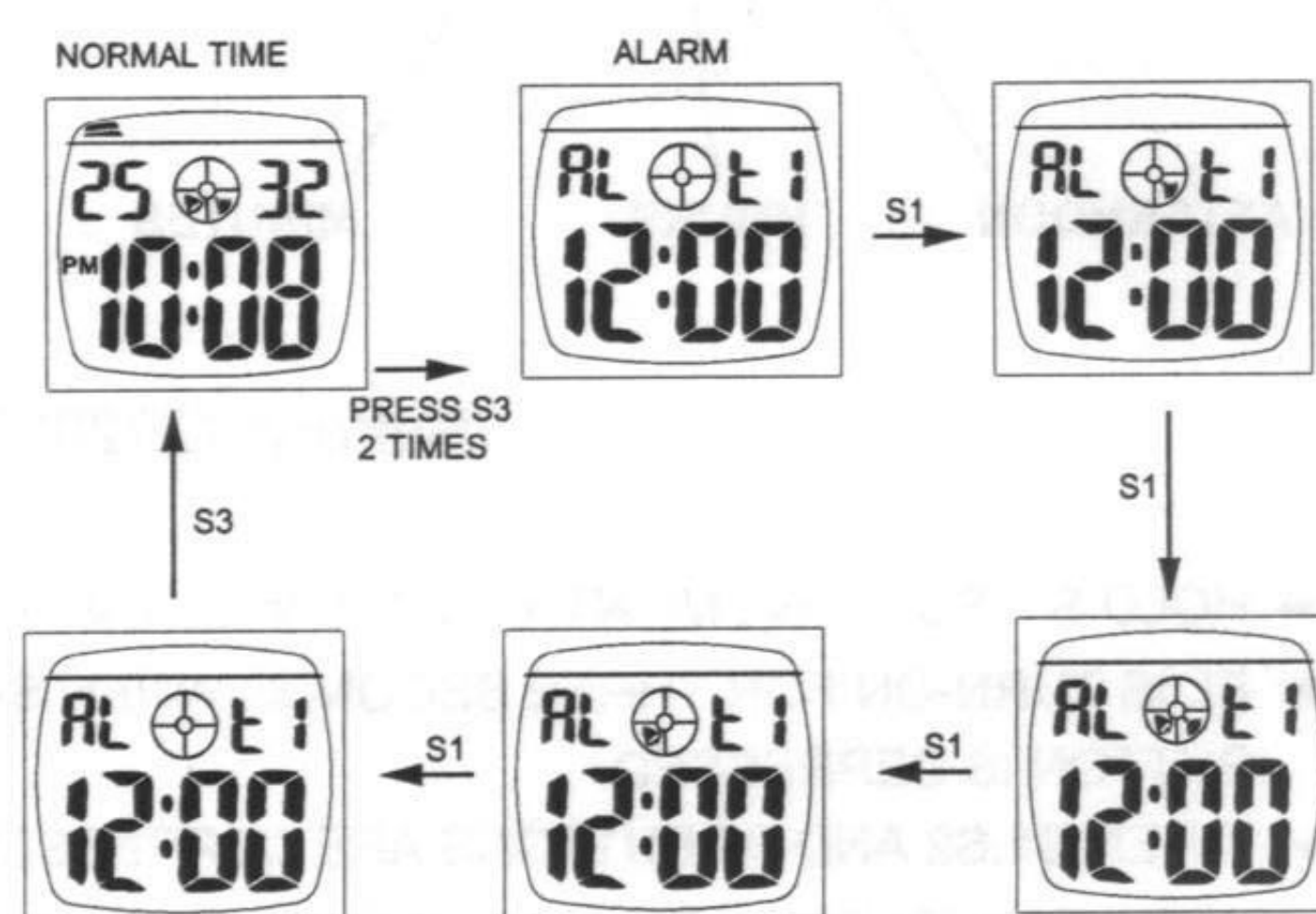

HOW TO USE TIMER

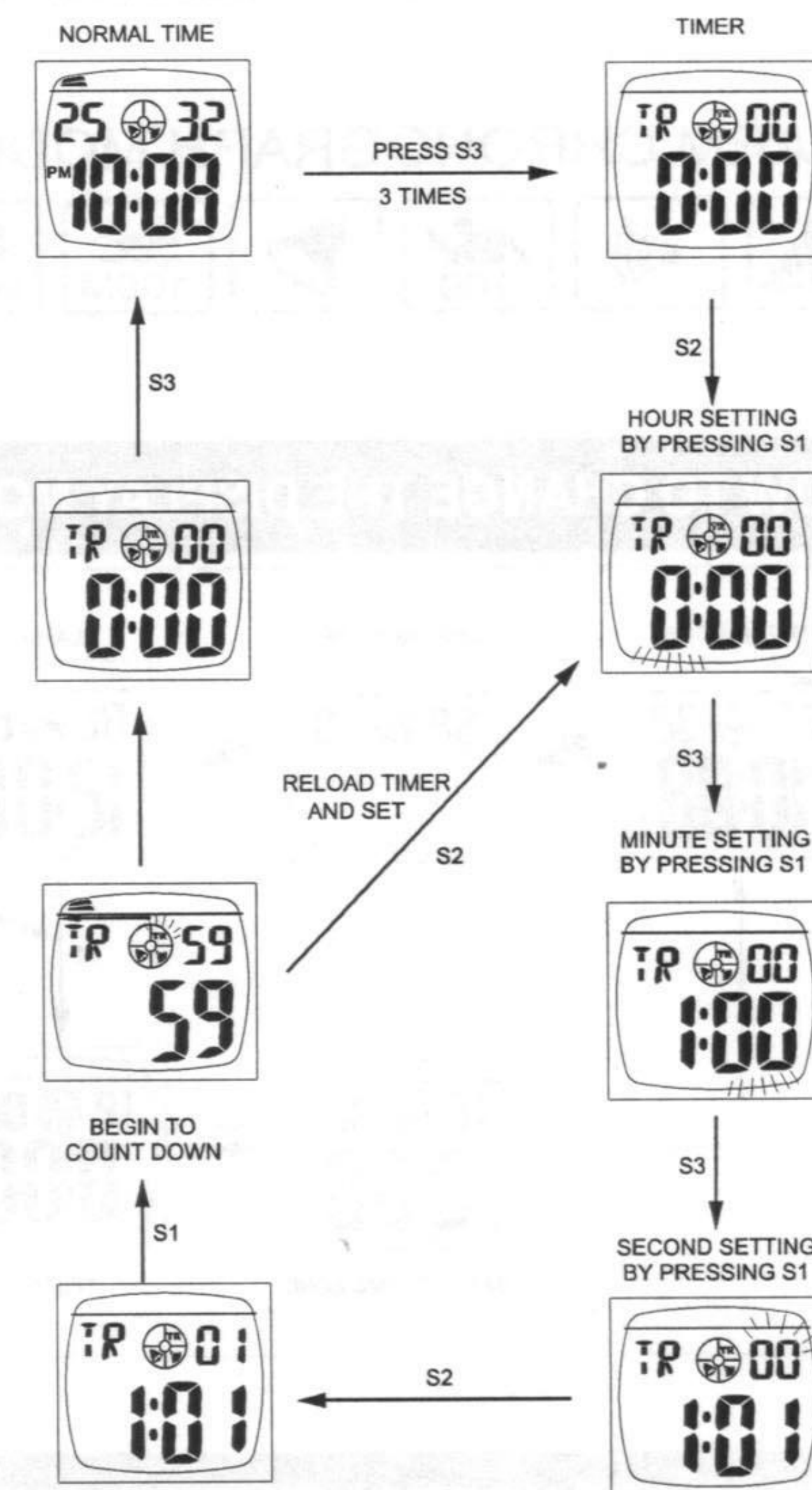

HOW TO SET SECOND TIME ZONE

