

## INSTRUCTION MANUAL 86303

### Features

- 1) 12digits display: Hour, Minute, Second, Month, Date, day of week.
- 2) Auto calendar from 2000 to 2049.
- 3) Daily alarm and hourly chime.
- 4) Dual time zone.
- 5) Count down timer with maximum of 23 hour, 59 minute and 59 second.
- 6) Chrono with 1/100 second.
- 7) 12 or 24 hour format.
- 8) EL backlight.

### LCD DISPLAY AND BUTTONS FUNCTION

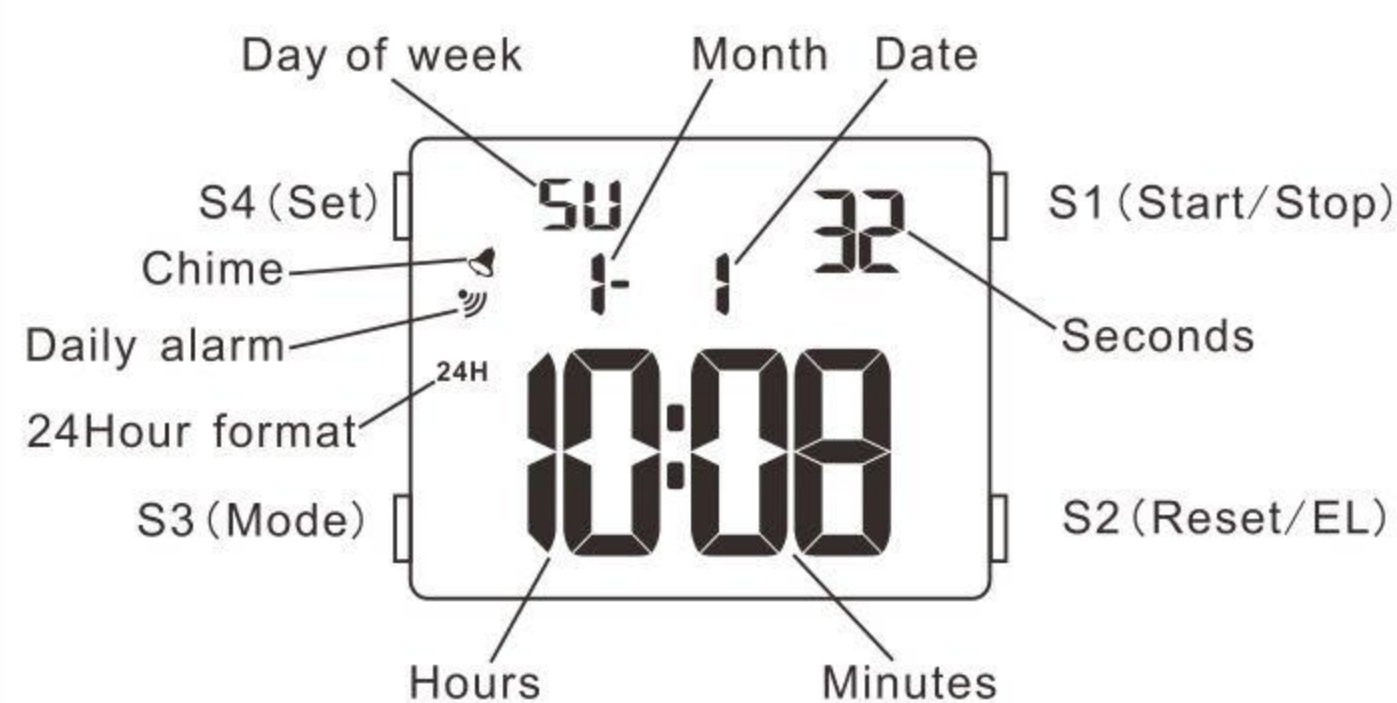

### HOW TO SET NORMAL TIME/CALENDAR

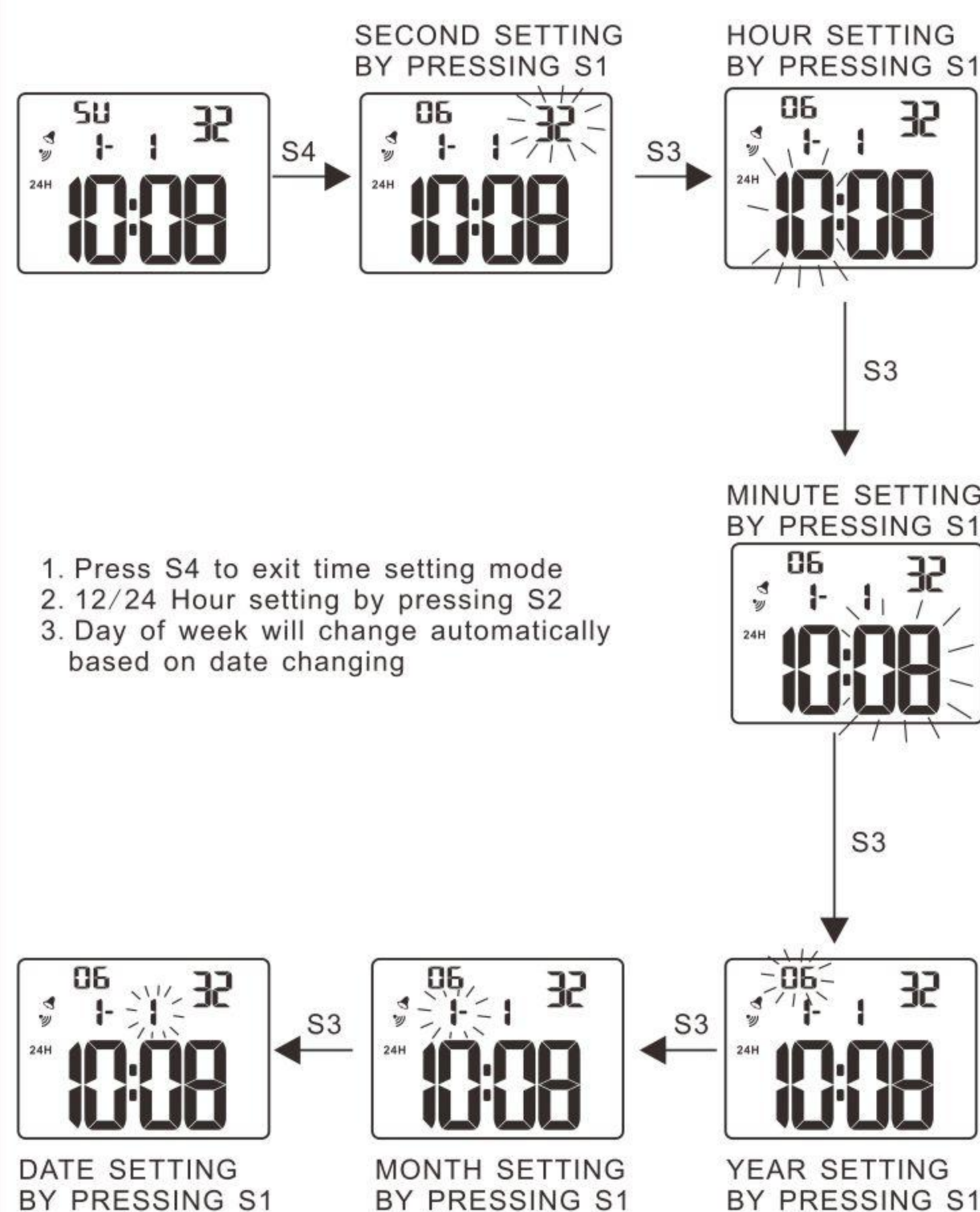

### HOW TO SET ALARM TIME

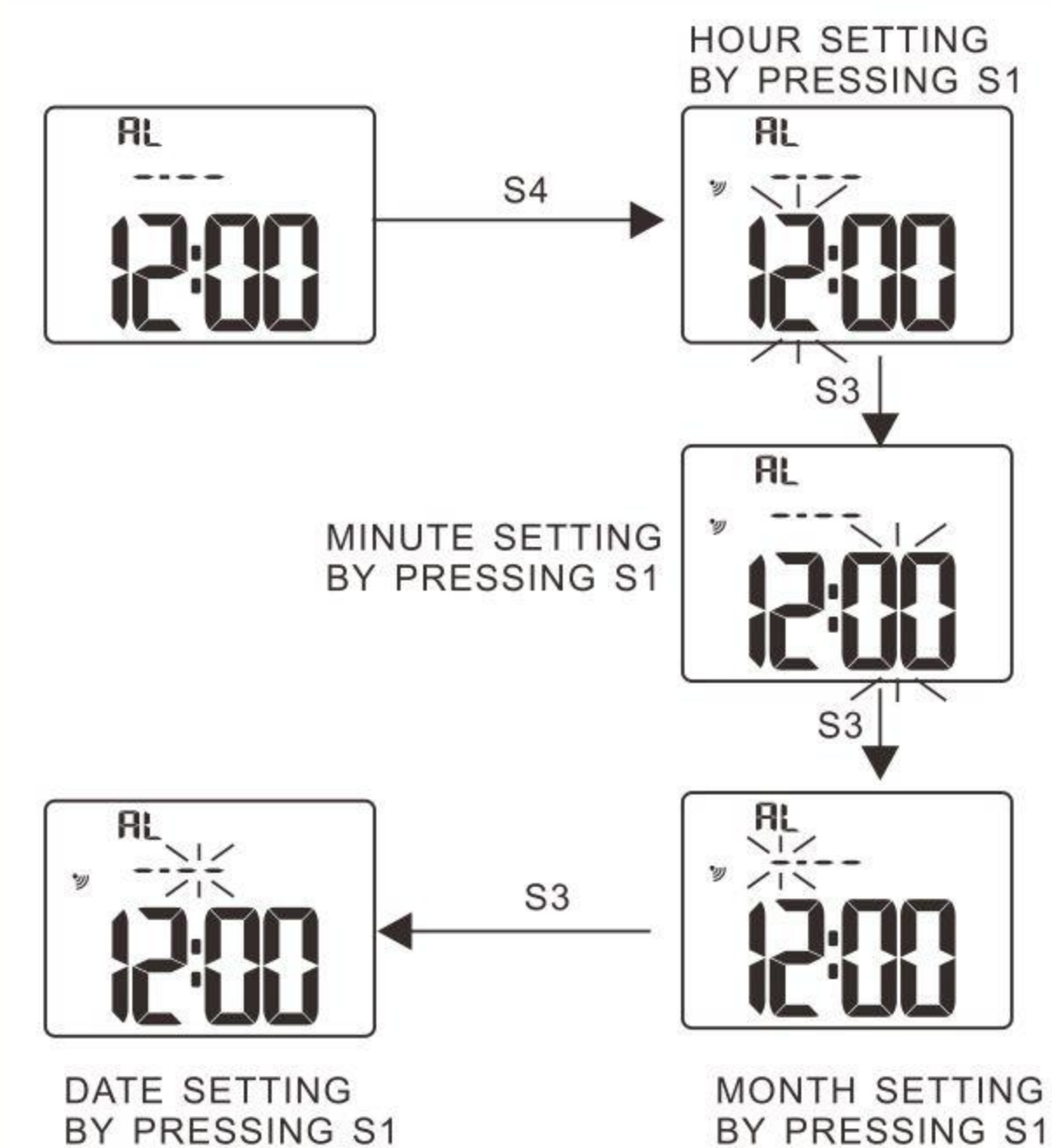

### ALARM & CHIME ON/OFF

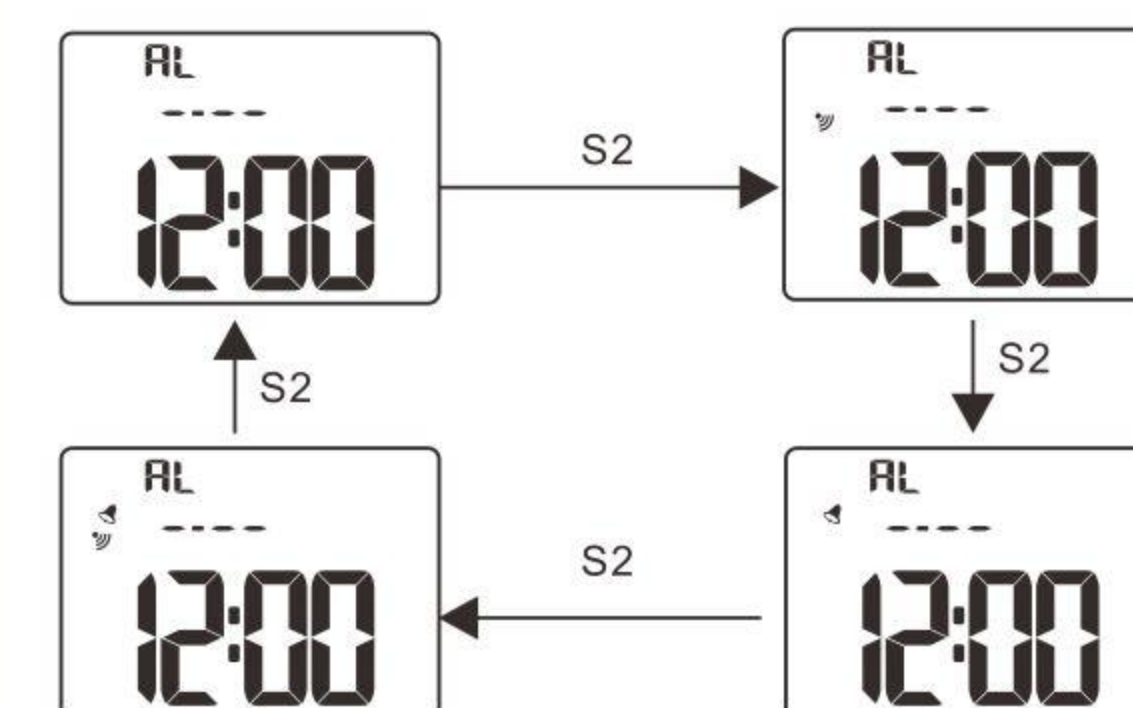

1. Press S4 to exit alarm setting mode.
  2. Press S3 back to Normal time.
  3. "RL" Means daily alarm.
- If set month and date, will alarm once.

### HOW TO SET COUNT DOWN TIMER

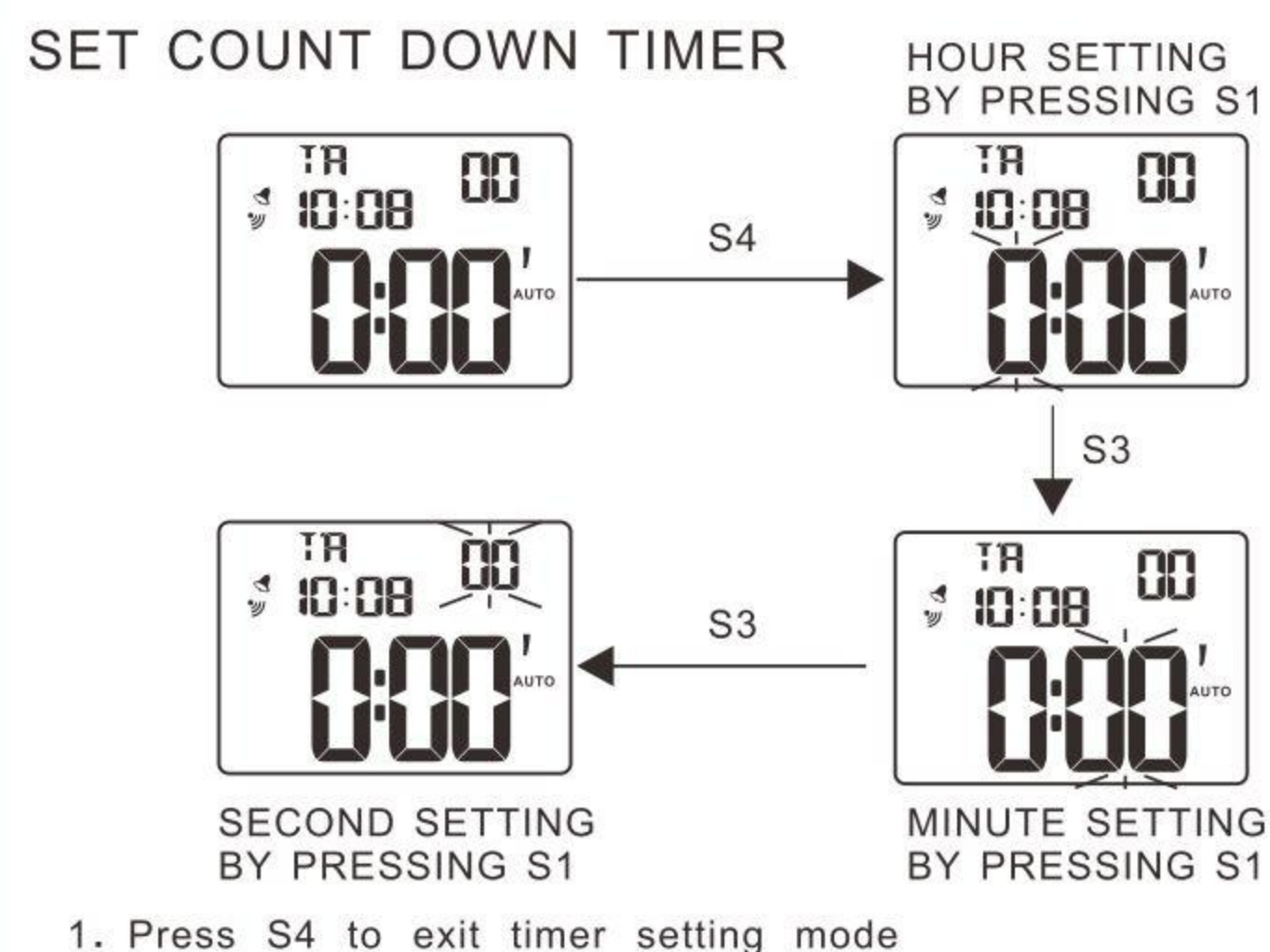

### RUN COUNT DOWN TIMER

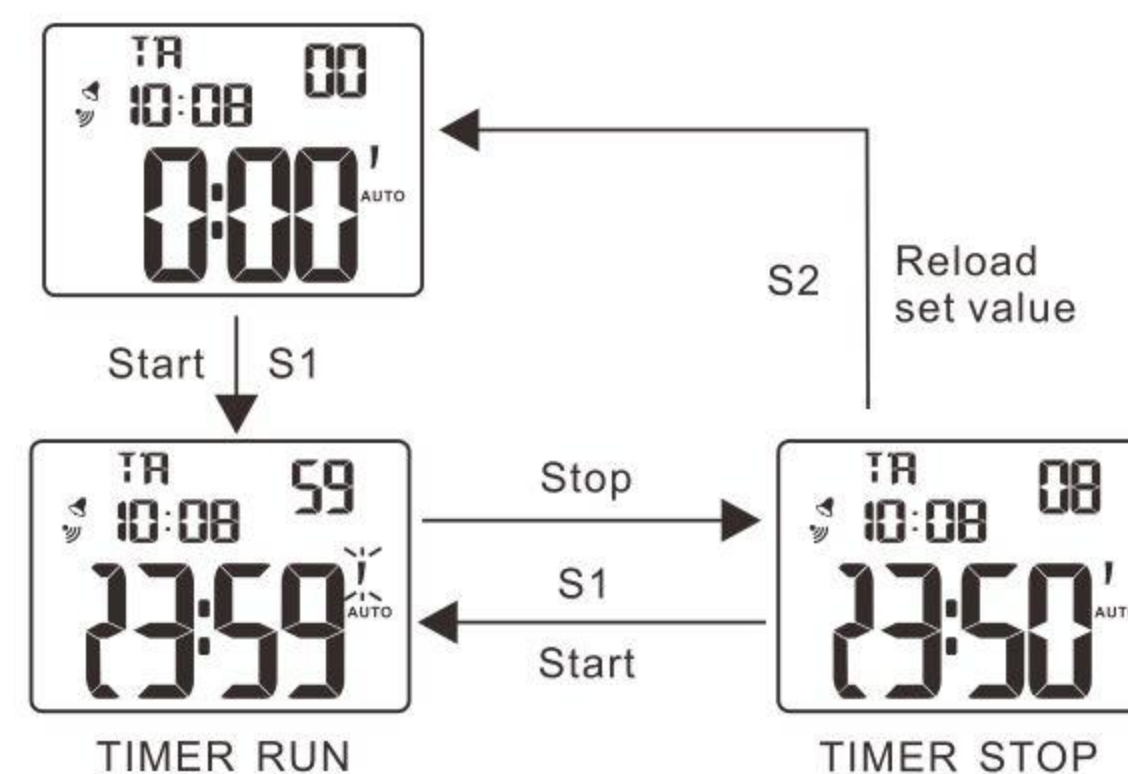

### HOW TO SET SECOND TIME ZONE

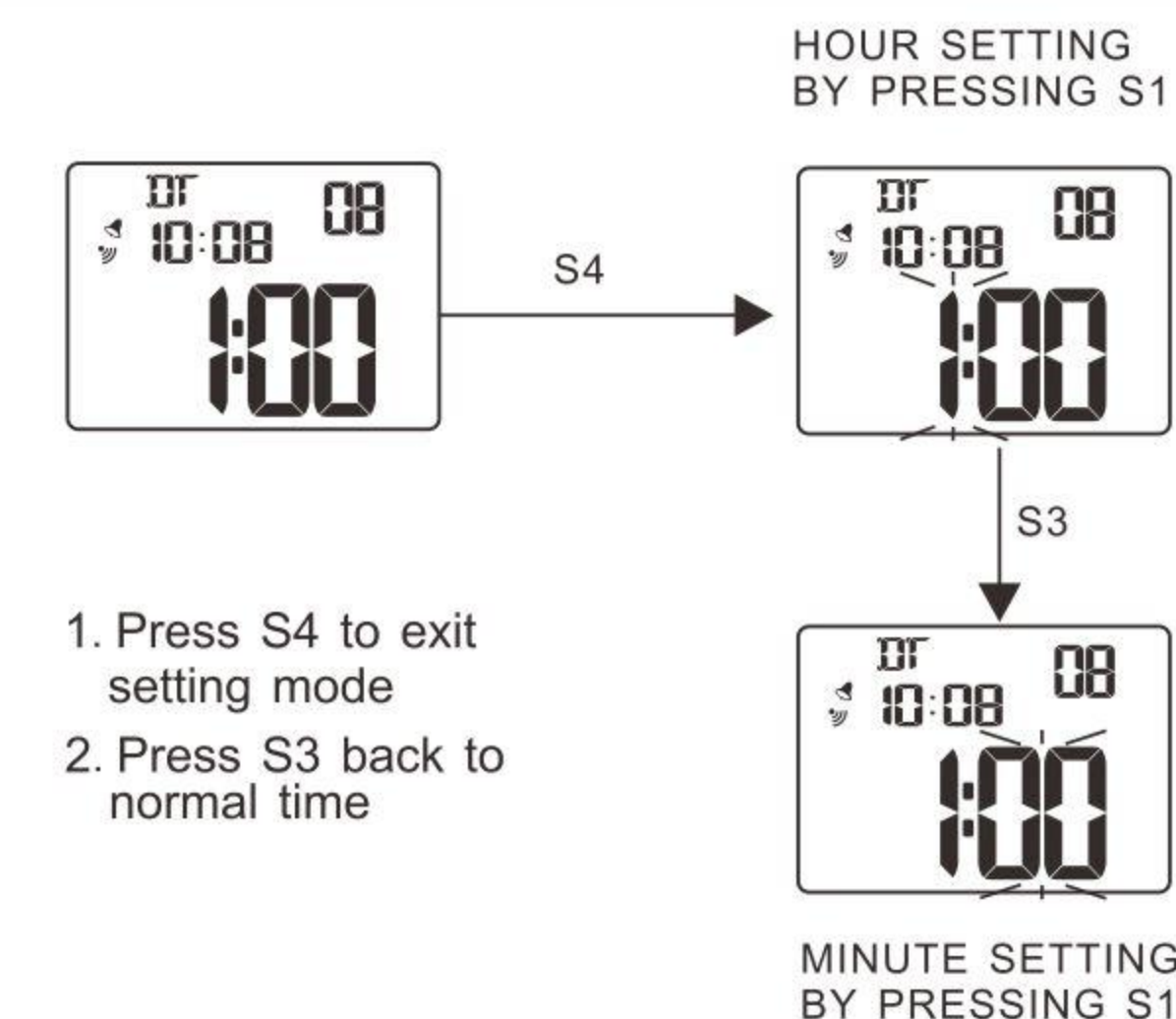

### HOW TO USE CHRONOGRAPH

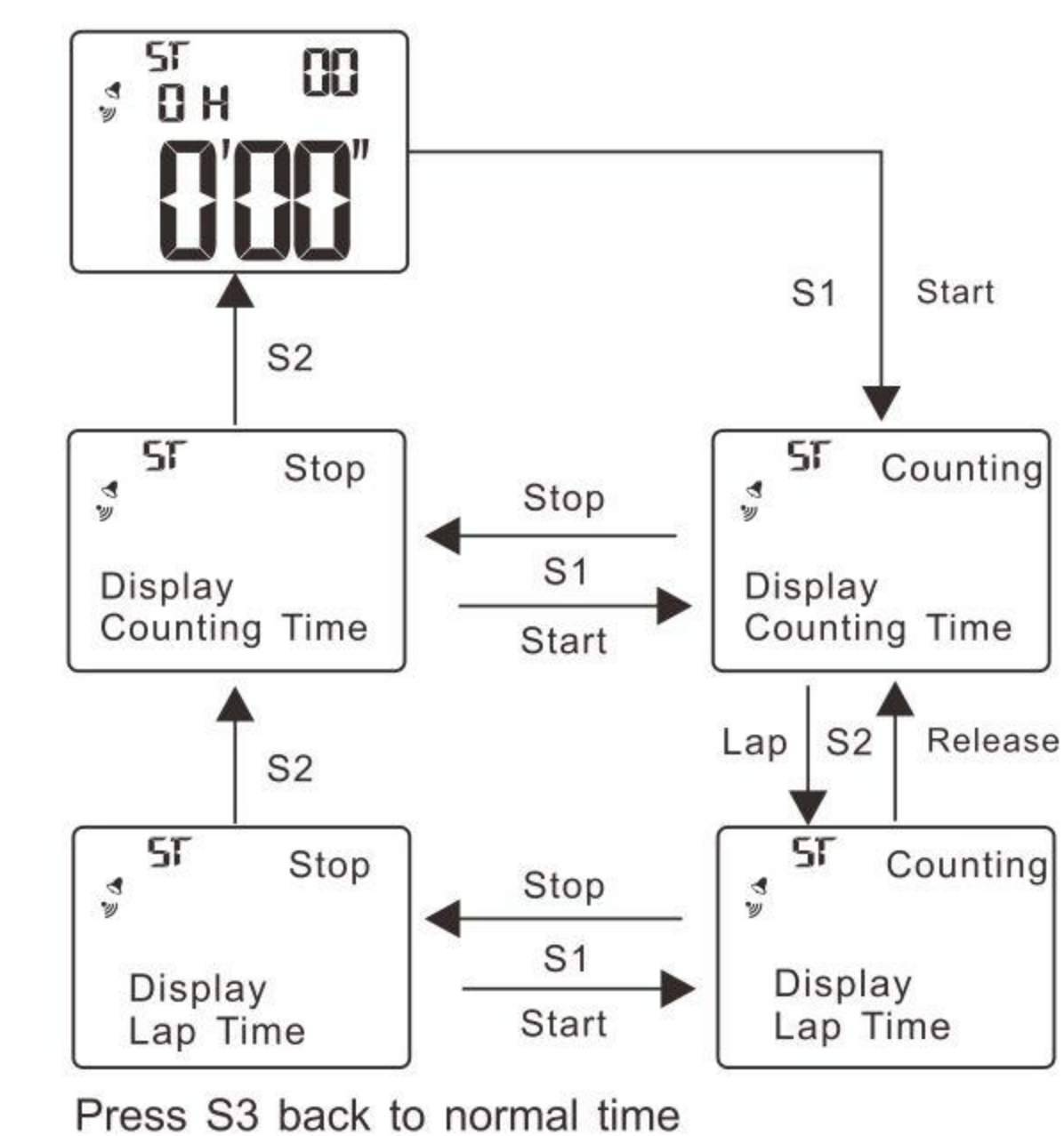

### CARE OF YOUR WATCH

1. This watch contains electronic components. Never attempt to open the case or remove the back cover.
2. Do not operate push buttons below the surface of the water while swimming or diving.
3. Should water or condensation appear in the watch, have the watch checked immediately. Corrosion of electronic parts can occur inside the case.
4. Avoid severe impact. The watch is designed to withstand impact under normal use. It is inadvisable to subject it to severe impact or rough usage.
5. Avoid exposing the watch to extreme temperature.
6. Clean the watch with soft cloth and clean water only. Avoid using chemicals.
7. Keep your watch away from the conditions of strong electric field and static electricity.

### HOW TO CHANGE THE DISPLAY MODE

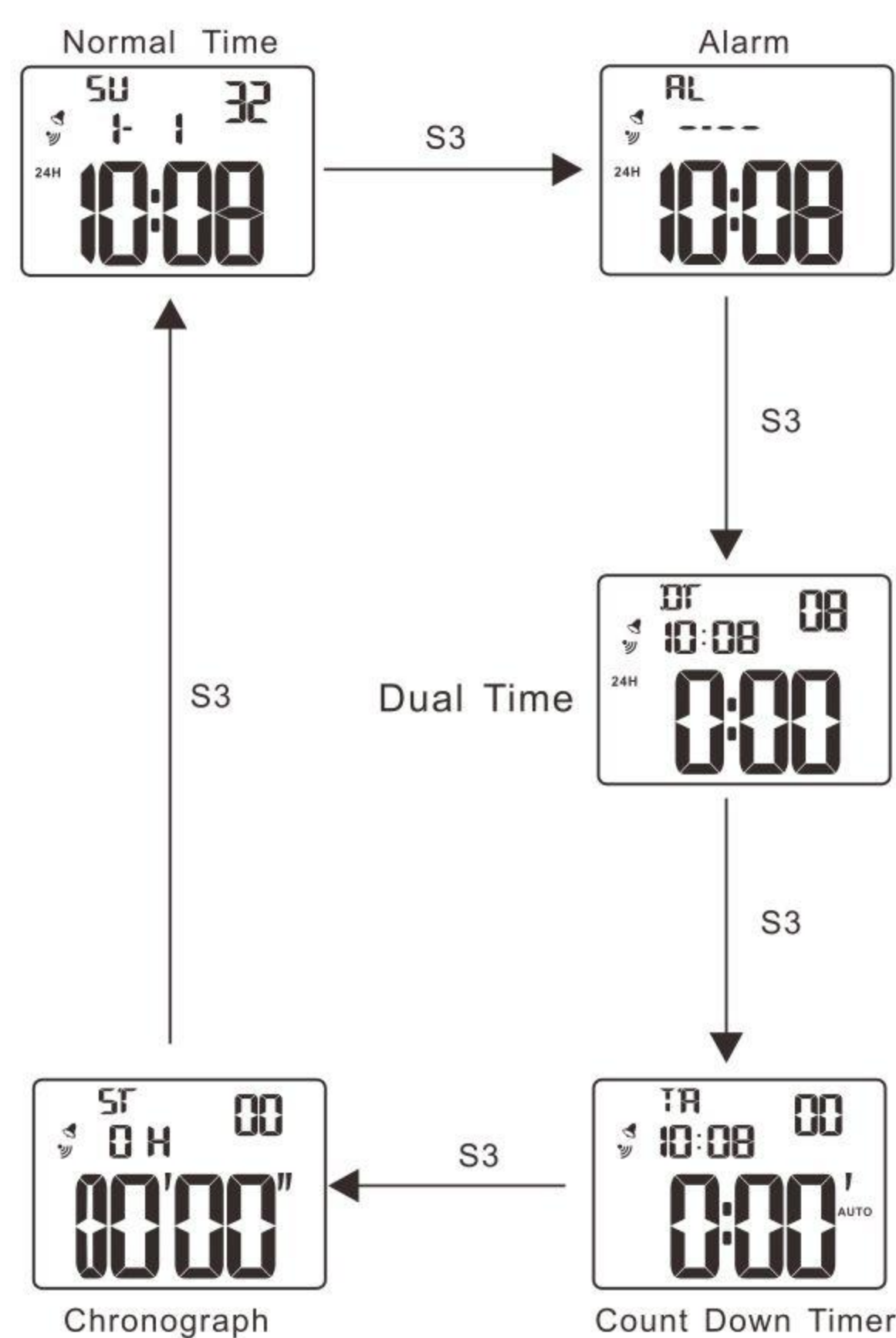

"RL" Means "Daily Alarm" "TR" Means "Timer"  
"DF" Means "Dual Time" "SF" Means "Stopwatch"